

# System performance of slow-light buffering and storage in silicon nano-waveguide

Yikai Su<sup>\*a</sup>, Fangfei Liu<sup>a</sup>, Qiang Li<sup>a</sup>, Ziyang Zhang<sup>b</sup>, Min Qiu<sup>b</sup>

<sup>a</sup>State Key Lab of Advanced Optical Communication Systems and Networks, Department of Electronic Engineering, Shanghai Jiao Tong University, 800 Dongchuan Rd Shanghai 200240, China, \*email: [yikaisu@sjtu.edu.cn](mailto:yikaisu@sjtu.edu.cn);

<sup>b</sup>Department of Microelectronics and Applied Physics, Royal Institute of Technology (KTH), Electrum 229, 164 40 Kista, Sweden

## ABSTRACT

We experimentally demonstrate optically tunable buffer in a nano-scale silicon microring resonator with a 20- $\mu\text{m}$  radius. The delay-tuning mechanism is based on the red shift of the resonance induced by the thermal nonlinear effect. We use a non-return-to-zero (NRZ) pseudo random bit sequence (PRBS) signal with different data rates as the probe signal, and investigate its delay performance under different pump powers.

**Keywords:** Slow light, Silicon microring resonator, thermo-optic effect

## 1. INTRODUCTION

Optical buffering and storage are key technologies in future all optical packet-switched networks as well as optical interconnections in computer systems to avoid traffic contention. Slow light has become a potential candidate for achieving optical buffering by reducing the group velocity of the light in certain media, and it has attracted great interest in the research field. Slow lights have been demonstrated based on a spectral gain or absorption [1] in different media such as atom vapors [2], fibers [3] and semiconductors [4]. For a slow light delay line, it has to be compact and able to provide large delay per unit length especially when it is used in all optical interconnection for computer systems.

The recently developed silicon-on-insulator (SOI) structure has been proved to be an excellent platform for monolithic integration of photonic devices due to its high index contrast between the silicon core and the silica cladding, which allows strong confinement of light and makes the buffer have very small volume. Some slow light delay lines based on silicon waveguide have been demonstrated including cascaded microring resonator based all pass filters (APF) structure and coupled resonator optical waveguides structure [5], stimulated Raman scattering (SRS) controlled slow light in silicon waveguide [6] as well as SRS effect based slow light enhanced by resonator [7]. Among these methods, microring-resonator based structures are promising for buffering, which can provide large group delay and enable compact footprint. These structures include single-channel side-coupled integrated spaced sequence of resonators (SCISSOR), double-channel SCISSOR, and inter-coupled resonators [8]. In these structures, single microring resonator is the critical unit, although it can only induce an enhanced group delay. This paper focuses on the system performance of a single microring resonator in delaying data sequences.

Tunable delay line is a key issue for a practical buffer. The tunability of the microring resonators is achieved by changing the group delay of each single microring resonator. There are mainly three types of methods to realize tunable delay in a microring resonator: 1) electro-optic effect by doping the intrinsic silicon to form a p-i-n structure [9]; 2) thermo-optic effect by implanting a micro-heater in the microring resonator [10]; 3) MEMS actuated structure [11]. However, these methods need additional procedure in the fabrication process. As the absorption of a pump light would be eventually converted to the thermal energy [12], the injection of the pump light can also lead to thermal nonlinear effect and red-shift the resonance, which could be used to change the group delay of a probe signal by changing the intensity of the pump power. It has the lowest threshold in all the nonlinear effect phenomena in the silicon waveguide. In this paper, we experimentally investigate the delay of a non-return-

to-zero (NRZ) pseudo random bit sequence (PRBS) data at different rates passing through a 20- $\mu\text{m}$ -radius single side coupled silicon microring resonator, which is controlled by a continuous wave (CW) pump signal. We also show the tuning of the group delay by varying the probe-signal wavelength. Although the experiment is demonstrated using a single microring resonator, we believe that this simple group delay tuning method is applicable for the microring resonator based slow-light structures.

If the light is significantly slowed down or even stopped, it is possible to store signals in the silicon microring resonator based structures. We will review some works in the storage of the light in the silicon microring resonators at the end of the paper.

## 2. DEVICE AND ITS COUPLING TO FIBER

The 20- $\mu\text{m}$ -radius silicon microring resonator in our experiment is fabricated on an SOI wafer with a 250-nm-thick silicon slab on the top of a 3- $\mu\text{m}$  silica buffer layer. The cross section of the silicon waveguide is 450 $\times$ 250 nm. The microring is side coupled to the straight waveguide with an air gap of 120 nm between the straight waveguide and the microring. The scanning electron microscope (SEM) photos of the silicon microring resonator are shown in Fig. 1.

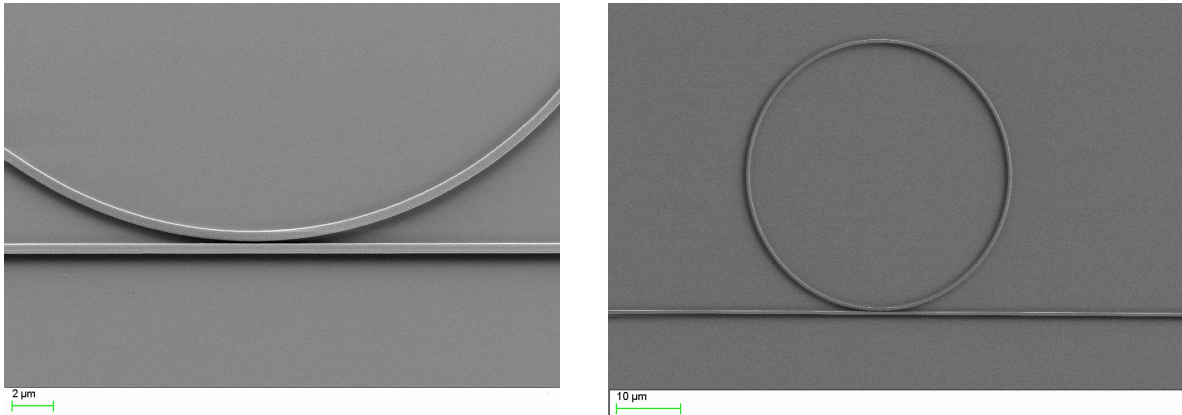

Fig. 1. SEM photos of the silicon microring resonator with a radius of 20  $\mu\text{m}$ .

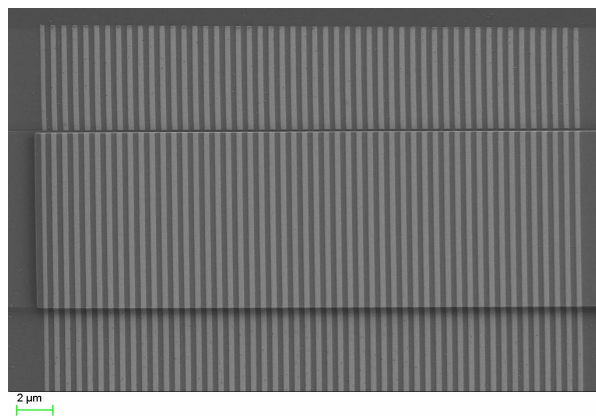

Fig. 2. SEM photo of the gold grating coupler.

At each end of the straight silicon waveguide, there is a gold grating coupler to couple light between the single mode fiber (SMF) and the silicon waveguide efficiently. Fig. 2 shows the SEM photo of the gold grating coupler at

the end of the straight waveguide. This vertical coupling method can support TE mode [13]. The input and output fibers should be placed under a certain angle (typically 10 degrees) relative to the vertical axis. There is an adiabatic taper between the grating coupler and the 250- $\mu\text{m}$ -long access straight waveguide. The gold grating coupler is wavelength sensitive and has a 3dB bandwidth of 30 nm around the 1550-nm telecommunication wavelength. The theoretical fiber-to-fiber coupling loss is  $\sim 14$  dB and the measured value is  $\sim 20$  dB.

### 3. OPERATING PRINCIPLE AND EXPERIMENT SETUP

#### 3.1 Operating principle

The linear transfer function of a single side coupled microring resonator can be expressed as follows [7]:

$$T(\omega) = \frac{t - a \exp(i\phi)}{1 - t \exp(i\phi)} \quad (1)$$

where  $t$  is the transmission coefficient which is related to the coupling coefficient  $r$  as  $t = \sqrt{1 - r^2}$ .  $a = e^{-\frac{\alpha}{2}L}$  is the single pass attenuation in the ring, where  $L$  and  $\alpha$  are the length of the ring and the linear loss, respectively.

$\phi = kL$  is the linear phase shift of the ring,  $k = \frac{n_{\text{eff}}\omega}{c}$  is the propagation constant where  $n_{\text{eff}}$ ,  $\omega$  and  $c$  are the effective refractive index, angular frequency and speed of light, respectively. Therefore the group delay of the ring resonator can be expressed as [8]:

$$T_D = \frac{(1 - r^2)a^2}{1 - 2ra \cos(\phi) \frac{(1 + a^2)}{2} + r^2 a^2 + (\sin^2(\phi)(1 - a^2)^2)r^2 - (1 - a^2)} \frac{n_g L}{c} \quad (2)$$

where  $n_g$  is the group refractive index. Eq. (2) reveals that the group delay achieves its maximum in the resonance wavelength and is reduced when detuned from the resonance.

When a pump light with a power of  $P_A$  is injected to the microring resonator, the absorbed energy is eventually converted to the thermal energy and leads to a temperature shift  $\Delta T$  [12]:

$$\frac{d\Delta T}{dt} + \frac{\Delta T}{\tau_\theta} = -\frac{P_A}{\rho CV} \quad (3)$$

where  $\tau_\theta$  is the thermal dissipation time,  $\rho = 2.3 \times 10^{-3} \text{ kg/cm}^3$  is the density of the silicon,  $C = 705 \text{ J/(kg} \cdot \text{K)}$  is the thermal capacity, and  $V$  is the volume of the microring. The refractive index changes with the temperature as  $\Delta n_\theta = k_\theta \Delta T$ , where  $k_\theta = 1.86 \times 10^{-4} \text{ K}^{-1}$ . The change of the refractive index would red shift the resonance. As the thermo-optic coefficient is very large in silicon, this thermal nonlinear effect has a low power threshold. By using this method, the group delay can be changed by controlling the pump light with a low value.

#### 3.2 Experiment setup

The experiment setup is depicted in Fig. 3. The pump and the probe signal sit in two adjacent resonances in the vicinity of 1550 nm. The probe signal is modulated by an NRZ PRBS signal of  $2^7 - 1$  pattern length and the pump light is amplified by a high power EDFA followed by an attenuator to adjust the pump power. Both the pump light and the probe signal are coupled through a 3-dB coupler to the microring resonator by the vertical coupling system. As the gold grating coupler is polarization dependent, two polarization controllers are inserted before the coupler to make sure the input pump and probe lights are in TE mode.

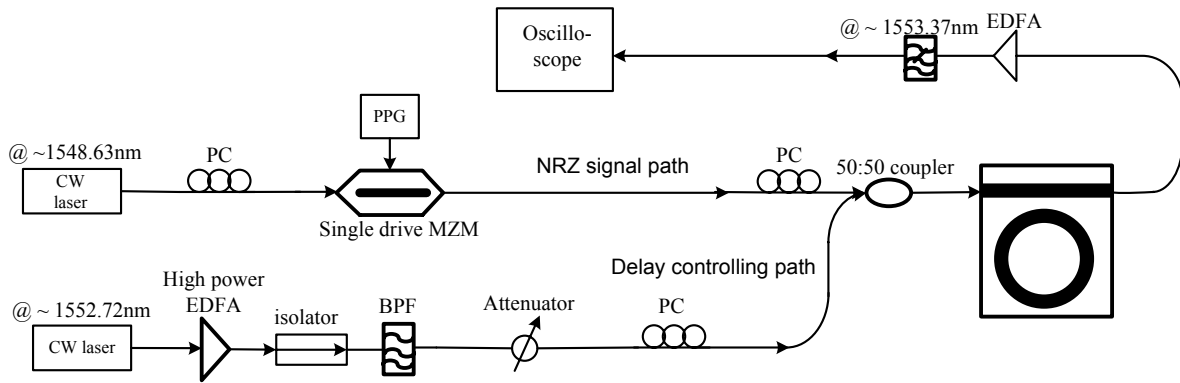
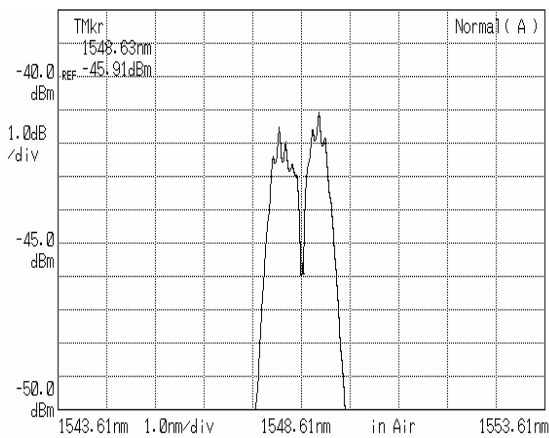

Fig. 3. Experiment setup of the demonstration of the optically tunable group delay of a single microring resonator.

## 4. EXPERIMENT RESULTS

### 4.1 Spectra response of the microring resonator

To measure the spectral response of the microring resonator, we use two cascaded EDFAs as the ASE source due to the large fiber-to-fiber loss and limited sensitivity of the optical spectra analyzer (OSA). The measured spectra of the two resonances are shown in Fig. 4(a) and (c). The two resonance wavelengths are 1548.61 nm and 1552.72 nm, respectively. The resonance at 1548.63 nm has about 5-dB notch and the one at 1552.72 nm has about 7-dB notch. As we use a bandpass filter with a bandwidth of 1.6 nm between the two EDFAs, the flat spectral range is  $\sim 1$  nm. The free spectral range (FSR) of the microring resonator is  $\sim 4.1$  nm. As the resolution of the OSA is limited to 0.07 nm, it is difficult to obtain the 3-dB bandwidth of the resonance from the spectrum. We also measured the spectra of the resonator by sweeping the tunable laser (Santec TSL 210F) with a step of 0.001 nm, which are shown in Fig. 4(b) (d). The 3-dB bandwidth is  $\sim 0.034$  nm for the resonance at 1548.63 nm and  $\sim 0.032$  nm for the resonance at 1552.72 nm. We set the pump wavelength at the upper verge of the resonance at 1552.72 nm and the signal wavelength is close to the resonance at 1548.63 nm.



(a)

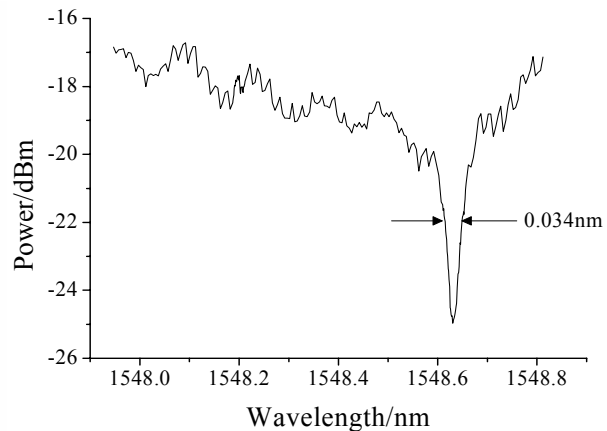

(b)

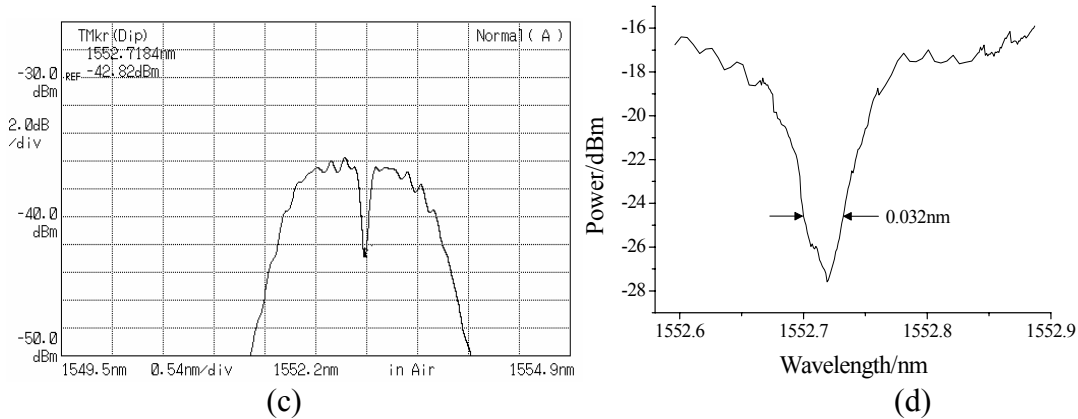

Fig. 4: (a) spectrum of the resonance at 1548.63 nm measured by the OSA, and (b) by sweeping the tunable laser, respectively. (c) spectrum of the resonance at the wavelength of 1552.72 nm measured by the OSA, and (d) by sweeping the tunable laser, respectively.

#### 4.2 Tunable delay of the NRZ PRBS data

We measured the delay performance of the NRZ PRBS signal at bit rates of 1 Gb/s, 5 Gb/s and 10 Gb/s by changing the pump power. To verify the red-shift effect, we set the wavelength of the NRZ signal at the left, center and right of the resonance, respectively. We find no change of delay when the NRZ signal is at the left of the resonance while there is obvious shift of the resonance as well as change of delay when the NRZ signal is at the right of the resonance, which prove that the resonance is red shifted when increasing the pump power.

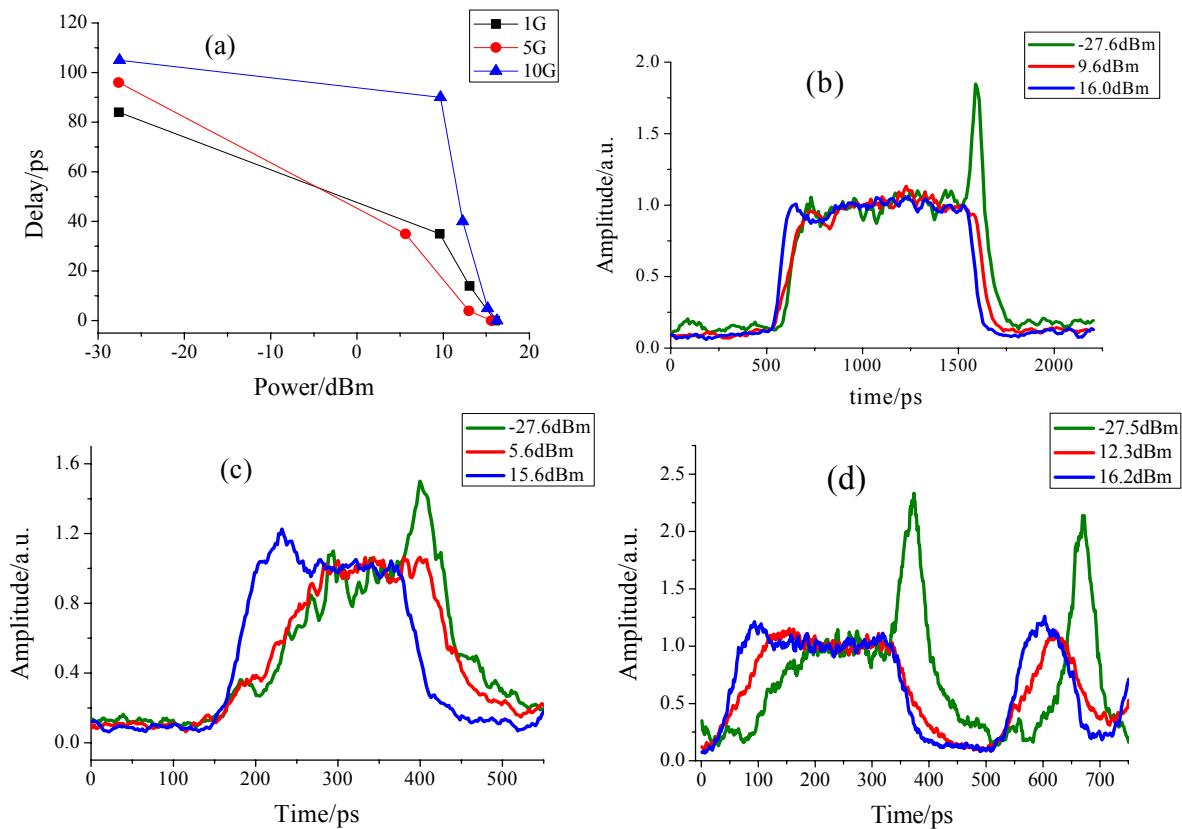

Fig. 5 (a) delay vs. pump power when the wavelength of the NRZ signal is at the center of the resonance. (b) (c) and (d) delayed waveforms of the NRZ signal when the data rate is 1 Gb/s, 5 Gb/s and 10 Gb/s, respectively.

Fig. 5 (a) shows the group delays as a function of the pump power when the NRZ signal is at the center of the resonance for bit rates of 1 Gb/s, 5 Gb/s and 10 Gb/s, and Fig. (b) (c) and (d) are the corresponding delayed waveforms at each data rate. We obtain the delay by comparing the rising edge of the waveform. One can see that when the NRZ signal is at the center of the resonance, the delay is decreased with the increasing of the pump power due to the spectral shift from resonance to off-resonance. The 1 Gb/s NRZ data preserves well except that a large overshooting appears in the falling edge of the pulse at the resonance wavelength due to the reservation of the high frequency components; For the 5 Gb/s signal, there are certain distortions. Large distortion can be observed for the 10 Gb/s signal at the resonance wavelength.

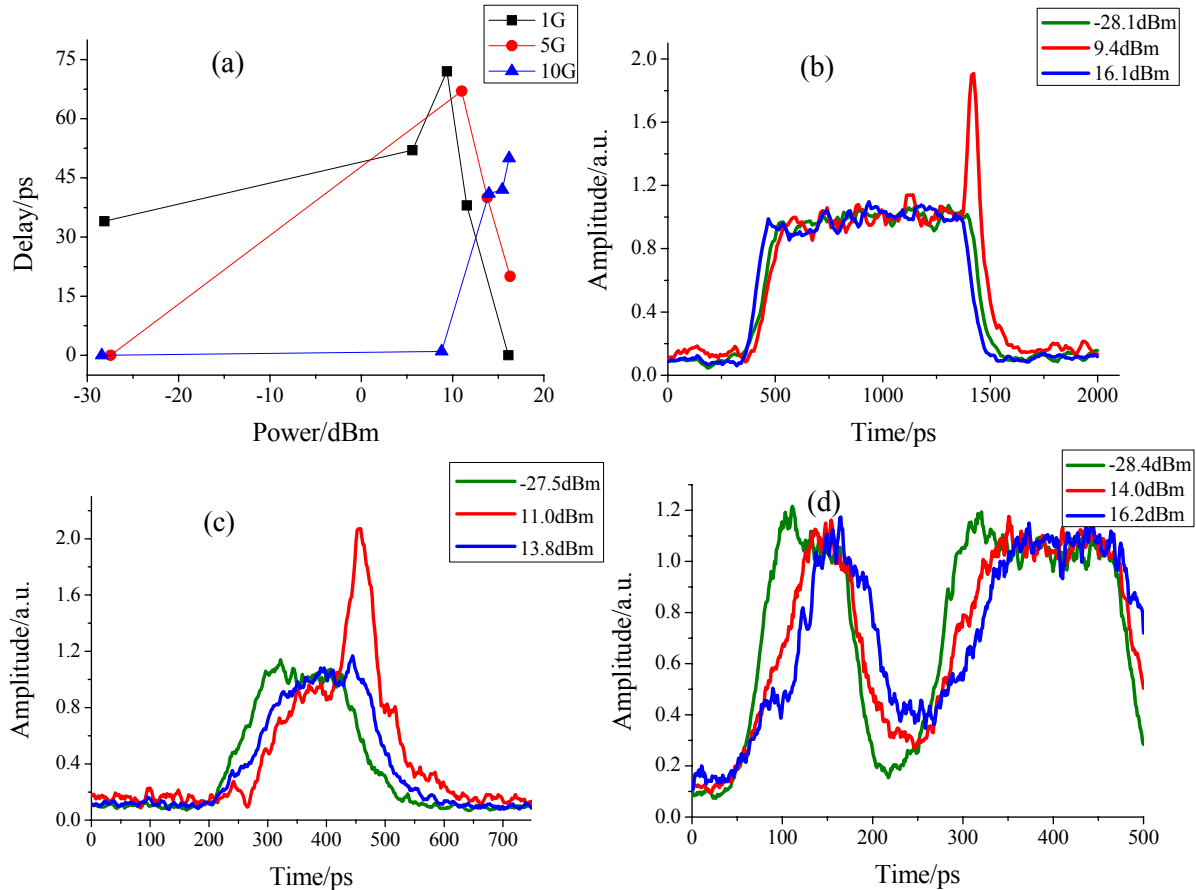

Fig. 6 (a) delay vs. pump power when the wavelength of the NRZ signal is at the right of the resonance; (b) (c) and (d) delayed waveforms of the NRZ signal when the data rate is 1 Gb/s, 5 Gb/s and 10 Gb/s, respectively.

From Fig. 6 (a), one can find that when the NRZ signal is at the right of the resonance, for the 1-Gb/s and 5-Gb/s signals, the increasing of the pump power red-shifts the spectrum so that the NRZ signal moves to the center of the resonance first, while further increasing the pump power makes the NRZ signal off resonance again. The 10-Gb/s NRZ signal does not reach the center of the resonance with the available pump power, which is due to the temperature variation of the environment. In both experiments, the pump power needed to shift the spectrum from resonance to off-resonance completely is  $\sim 15$  dBm at the input of the grating coupler. As the fiber-to-fiber loss of the vertical coupling system is 20 dB, we estimate that the pump power at the input of the microring is as low as 5 dBm. The average power of the NRZ signal injected to the grating coupler is  $\sim 5.7$  dBm in the experiment.

We also measured the delay as a function of the wavelength of the NRZ signal when the pump is off, together with the waveforms at typical wavelengths (Fig. 7). From the maximum delay of 140 ps at the resonance, we can estimate the delay-bandwidth product is about 0.59, which agrees with the results in [8]. Combined with the results in Fig. 5 and Fig. 6, we can estimate the tuning coefficient of the resonance wavelength versus the pump power.

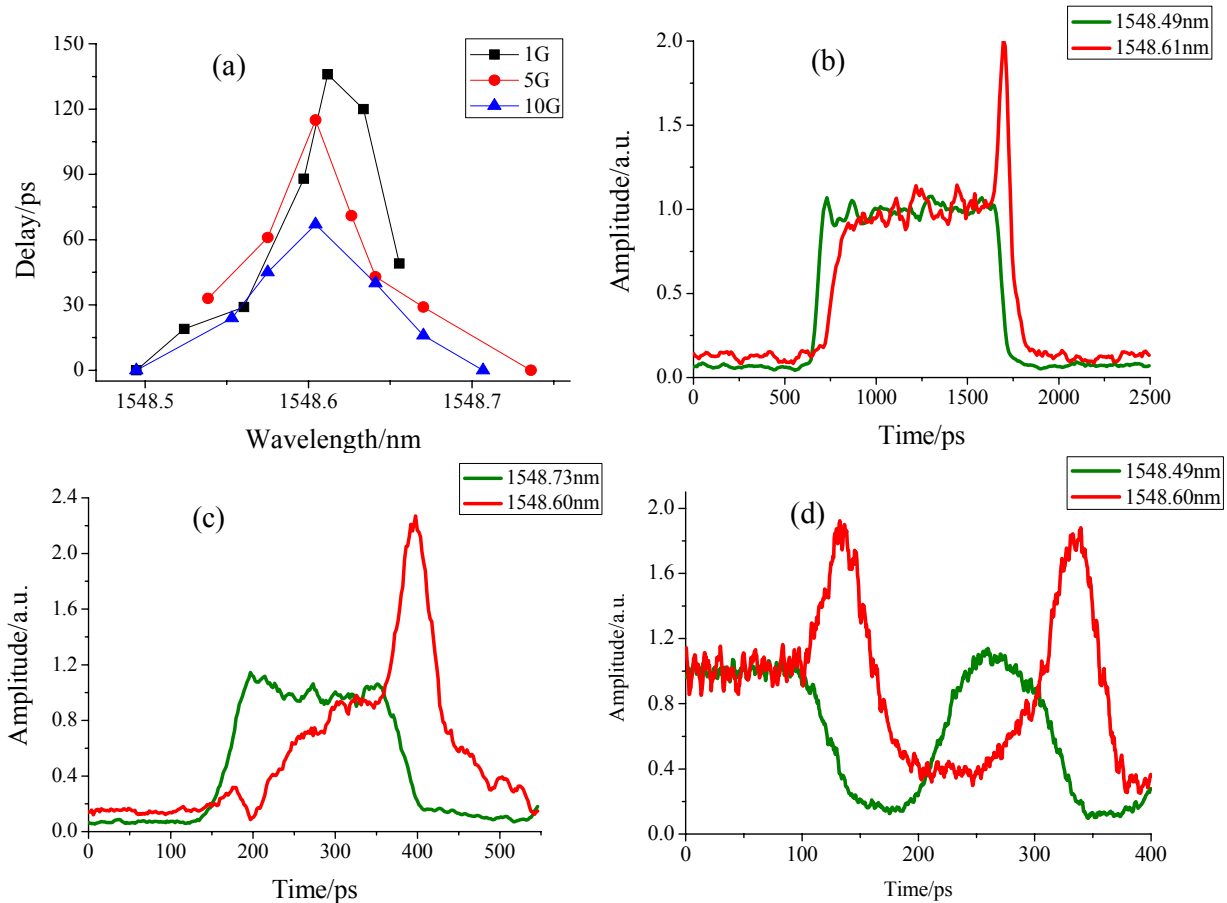

Fig. 7 (a) delay vs. the wavelength of the NRZ signal when the pump is off; (b) (c) and (d) delayed waveforms of the NRZ signal when the data rate is 1 Gb/s, 5 Gb/s and 10 Gb/s, respectively.

The tuning speed of our method is limited to the thermal dissipation time which is  $\sim 1 \mu\text{s}$ . Fast and dynamic tuning of the resonance can be used in the slow-light storage [14][15]. Ref. [14] has theoretically pointed out that dynamic tuning of the coupled resonator structure can stop light making slow-light storage possible; Ref. [15] has experimentally demonstrated a prototype of storing light using two silicon microring coupled to two parallel straight waveguides, which breaks the delay-bandwidth product of the resonator structure. Ref. [15] used an ultrashort pulse with a 1.5-ps pulse width to control the storage and release of the pulse by using the two photon absorption (TPA) induced carrier effect to tune the resonance. As this structure only has the potential to store one pulse, other building blocks for a practical storage of light such as series parallel converter as well as storage array with proper gate signal remain to be explored.

## 5. CONCLUSION

We have experimentally demonstrated an optically tunable group delay based on the thermal nonlinear effect in the silicon microring resonator induced by the absorption of the pump light. The pump light can shift the NRZ signal from resonance to off-resonance with only  $\sim 5\text{-dBm}$  pump power at the input of the microring, which corresponds to a delay tuning range of  $\sim 100$  ps. This method provides a simple and feasible way to achieve optically tunable slow-light buffer based on silicon microring resonator.

## 6. ACKNOWLEDGEMENT

This work was supported by the NSFC (60407008), the 863 High-Tech program (2006AA01Z255), the key project of Ministry of Education (106071), Shanghai Rising Star Program Phase II (07QH14008), and the Fok Ying Tung Fund (101067).

## REFERENCES

1. R. W. Boyd and D. J. Gauthier, "'Slow' and 'fast' light," *Progress in Opt.* **43**(6), 497-530 (2002).
2. L. V. Hau, S. E. Harris, Z. Dutton, and C. H. Behroozi, "Light speed reduction to 17 meters per second in an ultra cold atomic gas," *Nature* **397**, 594-598 (1999).
3. L. Yi., W. Hu, Y. Su, M. Gao, and L. Leng, "Design and system demonstration of a tunable slow-light delay line based on parametric process," *IEEE Photon. Technol. Lett.* **24**(18), 2575-2577 (2006).
4. A. V. Turukhin, V. S. Sudarshanam, M. S. Shahriar, J. A. Musser, B. S. Ham, and P. R. Hemmer, "Observation of ultraslow and stored light pulses in a solid," *Phys. Rev. Lett.* **88**(2), 023602 (2002).
5. F. Xia, M. Rooks, L. Sekaric, and Y. Vlasov, "Ultra-compact high order ring resonator filters using submicron silicon photonic wires for on-chip optical interconnects," *Opt. Express* **15**(19), 11934-11941 (2007).
6. Y. Okawachi, M. Foster, J. Sharping, A. Gaeta, Q. Xu, and M. Lipson, "All-optical slow-light on a photonic chip," *Opt. Express* **14**(6), 2317-2322 (2006).
7. S. Blair and K. Zheng, "Intensity-tunable group delay using stimulated Raman scattering in silicon slow-light waveguides," *Opt. Express* **14**(3), 1064-1069 (2006).
8. J. E. Heebner, "Nonlinear optical whispering gallery microresonators for photonics," Doctoral thesis (2003).
9. B. Schmidt, Q. Xu, J. Shakya, S. Manipatruni, and M. Lipson, "Compact electro-optic modulator on silicon-on-insulator substrates using cavities with ultra-small modal volumes," *Opt. Express* **15**(6), 3140-3148 (2007).
10. F. Morichetti, A. Melloni, C. Canavesi, F. Persia, M. Martinelli, and M. Sorel, "Tunable Slow-Wave Optical Delay-Lines", OSA Topical Meeting on Slow and Fast Light, Washington DC, paper MB2, July 2006.
11. D. Leuenberger, J. Yao, M. C. M. Lee, and M. C. Wu, "Experimental demonstration of MEMS-tunable slow light in silicon microdisk resonators," OSA Topical Meeting on Slow and Fast Light, Washington DC, paper TuC6, July 2006.
12. Q. Xu and M. Lipson, "Carrier-induced optical bistability in silicon ring resonators," *Opt. Lett.* **31**(3), 341-343 (2006).
13. S. Scheerlinck, J. Schrauwen, F. Van Laere, D. Taillaert, D. Van Thourhout, and R. Baets, "Efficient, broadband and compact metal grating couplers for silicon-on-insulator waveguides," *Opt. Express*, **15**(15), 9639-9644 (2007).
14. M. F. Yanik and S. Fan, "Stopping light all optically," *Phys. Rev. Lett.* **8**(92), 083901(2004).
15. Q. F. Xu, P. Dong, and M. Lipson, "Breaking the delay-bandwidth limit in a photonic structure," *Nature Phys.* **3**(6), 406-410 (2007).